

Manual

MWS 5MV / MWS8

Microprocessor Weather Station
with datalogger



REINHARDT System- und Messelectronic GmbH

Bergstr. 33, D-86911 Dießen-Obermühlhausen

Tel. 0049 - (0) 8196/934100 Fax 0049 - (0)8196/7005 or 1414

E-Mail: wetter@reinhardt-testsystem.de
<http://www.reinhardt-wetterstationen.de>

Table of contents

| | |
|---|-----------|
| 1 Caution | 5 |
| 1.1 Intended Use..... | 5 |
| 1.2 Safety Regulations..... | 5 |
| 1.3 Mounting..... | 5 |
| 2 Setting Up the Weather Station | 6 |
| 2.1 Installation of Hardware..... | 6 |
| 2.1.1 Overvoltage protection..... | 7 |
| 2.2 Software Installation..... | 8 |
| 3.1 Starting the Software..... | 9 |
| 3 Technical details | 10 |
| 3.1 In case of power failure..... | 10 |
| 3.2 Maintenance..... | 10 |
| 3.3 The sensors..... | 11 |
| 3.3.1 The Temperature Sensor..... | 11 |
| 3.3.2 The Humidity Sensor..... | 11 |
| 3.3.3 The Pressure Sensor..... | 11 |
| 3.3.4 The Wind Speed Sensor..... | 12 |
| 3.3.5 The Wind Direction Sensor..... | 12 |
| 3.3.6 Rain / Precipitation Sensor (Option)..... | 12 |
| 3.3.7 Light Intensity Sensor (Lux-Sensor) (Option)..... | 12 |
| 3.3.8 Ultraviolet-radiationsensor (UV-Sensor) (Option)..... | 12 |
| 3.3.9 Additional Sensor..... | 13 |
| 3.3.10 Connecting an Additional Sensor..... | 13 |
| 3.4 Sensor Accuracy..... | 14 |
| 3.4.1 Measuring Ranges..... | 14 |
| 3.5 Adjustment of Additional Sensors..... | 15 |
| 3.6 Power Supply..... | 16 |
| 3.6.1 Power consumption..... | 16 |
| 3.7 Data Format..... | 16 |
| 3.8 System requirements..... | 17 |
| 3.8.1 System requirements (16bit versions)..... | 17 |
| 3.8.2 System requirements (32bit-Versions)..... | 17 |
| 3.8.3 System Requirements for DOS-Versions..... | 17 |
| 3.8.3.1 SMARTDRIVE..... | 17 |

Manual MWS 5MV und MWS8

| | |
|---|-----------|
| 4 Connections and Pin assignments | 18 |
| 4.1 Cables | 18 |
| 4.1.1 Data Cable - Allocation of the Connection Cable for MWS 5M / MWS8 | 18 |
| 4.1.1.1 Connection Diagram Standard data cable | 18 |
| 4.1.2 Allocation of the Connection Cable for MWS 5M Heating..... | 19 |
| 4.1.2.1 Connection Diagram Cable for heating device | 19 |
| 4.1.3 Allocation of the Connection Cable for GPS-Receiver (Garmin GPS16-HVS) : | 19 |
| 4.1.4 Allocation of the Connection Cable for Heating and GPS-Receiver (Garmin GPS16-HVS): | 20 |
| 4.1.5 Allocation of the Connection Cable for Sensors with RS422-port..... | 20 |
| 4.2 Pin assignments..... | 21 |
| 4.2.1 Allocation of the MWS 5MV / MWS8-Connection Sockets | 21 |
| 5 Excerpts from the Directions of DWD for Automatic Weather Stations | 22 |
| 6 Trouble Shooting | 23 |
| 6.1 Fault Protocol File (16 bit versions)..... | 23 |
| 6.2 Protocol-files (32 bit versions)..... | 23 |
| 6.2.1 Log-file in case of error (ErrLog.txt) | 23 |
| 6.2.2 Logfile when starting up (log.dat) | 23 |
| 6.3 RS422/RS485 port | 24 |
| 7 Options | 25 |
| 7.1 Option LCD-Display..... | 25 |
| 7.1.1 Ways of displaying the data | 25 |
| 7.1.2 Changing the Configuration | 25 |
| 7.1.3 Commands for Controlling the Display..... | 26 |
| 7.1.3.1 Control parameteres | 26 |
| 7.2 Other available displays | 27 |
| 7.2.1 Meteograph | 27 |
| 7.2.2 DKA1 | 27 |
| 7.2.3 DMG | 27 |
| 7.2.4 DMMG | 27 |
| 7.2.5 DMMK | 27 |
| 8 Technical Appendix | 28 |
| 8.1 Control parameters for calibrating an additional sensor..... | 28 |
| 8.2 Controlling the Microcontroller..... | 29 |
| 8.2.1 Input parameters of MWS5MV / MWS8 -Microcontroller | 29 |
| 8.2.2 Querying the Microprocessor | 32 |
| 8.2.3 Order of the MWS5M / MWS8 Sensors | 33 |
| 9 Instructions for Mounting the MWS5M Weather Station | 34 |
| 10 Packing MWS 5MV / MWS8 properly | 35 |
| 11 Exchange Connectors | 35 |



MWS 5MV MicroprocessorWeather Station

Version 3.50 or later



MWS 8 MicroprocessorWeather Station

1 Caution

1.1 Intended Use

REINHARDT-Weather stations and sensors are exclusively built for stationary operation on a fixed 1" pipe for automatically collecting climatic parameters outside.

Any use other than described above may cause damage of the product or or other danger.

Do not mount the weather station in reach of children and pets.

Carefully read the complete operating manual. It contains important information about the installation and operation.

If the MWS 5MV / MWS 8 is not used for a longer period of time you should store it lying to prevent escaping the lubricant from the ball bearings!

1.2 Safety Regulations

The instruments are manufactured according to modern technical standards and can be operated without danger when used as directed.



Damage caused by non-observance of this operating manual can lead to forfeiture of warranty. We shall not assume any liability for subsequent damage.

We shall not assume any liability for damage of items or persons caused by improper handling or non-observance of the safety instructions! In such cases any guarantee claims shall become null and void.



Dear customer, the following safety and hazard notices not only serve the protection of your health but also the protection of the appliance. Please read the following points carefully.



The supply voltage is converted by isolated transformers into voltages of maximum 24VDC. (The stations can be operated at voltages up to 28VDC). Please do only use the supplied power supply units.



The weather station includes pointed and sharp-edged parts (i.e. windvane and edges of the sensor's housing), which may cause injuries when handled without care.



Do not leave the packaging material lying around. These parts are dangerous toys in the hands of children.

Handle the product with care. Blows or impact, or dropping it even from a small height will damage it.

1.3 Mounting

The weather station is mounted on a 1" water-pipe. This pipe must be fixed very well to stand high wind speeds above 150 km/h when the weather station is mounted.

The weather station is to be fixed well onto the 1" pipe with the screws. The stability of the weather station on the pipe must be established. Really check this after mounting the weather station!

Please mount the weather station on a place you easy can reach for maintenance purposes for the station can not be guaranteed to be absolutely maintenance free!!



You'll also find advice for mounting the weather station on your weatherCD.

2 Setting Up the Weather Station

2.1 Installation of Hardware

MWS 5MV and MWS8 Weather Station has been designed for measuring the most important weather parameters temperature, humidity, barometric pressure, wind direction and wind speed. All parameters can be displayed graphically, digitally or as an "multiple display". There is also a statistics and a history function.

Mount the weather station on a 1 " pipe. Orient the North-marker to North and clamp MWS 5MV / MWS8 in place with the two pre-mounted high quality steel screws. Take care that the pipe is mounted as perpendicularly as possible, otherwise the windvane will not work properly and will preferably rotate in one direction.

N.B.

The wind vanes of the MWS 5MV / MWS8 weather station are very sensitive sensory equipment which can easily be destroyed by mechanical influence.

Therefore do keep the packing of your weather station. Whenever you want to ship your weather station later, this packing guarantees that the weather station is not damaged in transport !! Time and again we have noticed that the units are damaged by wrong packing. This is very annoying for the customer because he has to pay for all costs that may arise.

Please ask for a quotation of an original packing if it is no longer available to you (see last page).

The weather station must be set up at a place which is exposed to wind, because otherwise wind direction and wind speed cannot be measured correctly. (Please see "Directions of Deutscher Wetterdienst").

Connect the enclosed cable as follows:

Connect the 9pole connector to a free serial interface of your PC (COM1 or COM2 under the Windows-version COM3 or COM4 as well).

Plug the power supply into a power outlet 100-240VAC / 50-60Hz.

Note on Security



Please note that you must in any case use the power supplies which we have provided or which are technically identical with your MWS 5MV/ MWS8 weather station. Nominal value must be between 4 V and 28 V DC voltage; it must be possible to apply at least 100 mA (with optional heating element another 18 or 24VDC 1 A). Please note also that all the power supplies we provide are only made for use in dry rooms.

There are another two sockets for additional sensors and for an optional GPS-receiver. Power supply of the additional sensors can be provided by the weather station or by their own power supply. The output voltage of the additional sensors must not exceed +4.095 V, sensors with pulse output must be TTL-compatible.

2.1.1 Overvoltage protection

The MWS 5MV / MWS8 contains an integrated overvoltage protection (Suppressordiodes) at its supply- and data wires.

The power line is protected by a SMCJ26CA-diode. This diode breaks through at voltages above 31VDC and is able to carry up to 1500W for a few milli seconds.



CAUTION: If you connect voltages above 30VDC permanently to the power jack, this diode will be destroyed within a few seconds!

The data lines are protected by SMBJ15CA-diodes able to carry transients up to 600W.

Also the housing made of high quality steel is connected to system ground.

This protection is suitable for protecting the station from damage due to overvoltage at close lightning strikes.

For protection of the connected peripherals (computer, camera, i.e.) the customer has to take further precautions (line protection, opto couplers, i.e.).

But please note that this protection is ineffective in case of direct lightning strike due to extremely high energy of lightning!

Currents of up to 200.000A can cause voltages up to 20.000V on the housing which leads to flashovers onto the internal electronic components and its destruction.

After installing the hardware you install the software.

2.2 Software Installation

Insert the WeatherCD into your CD-drive.

You need an HTML-capable browser (Netscape, Internet-Explorer or else).

If Autostart is activated, the CD starts on its own, if not, you execute STARTER.EXE in the CD root directory. Now you follow the instructions of the WeatherCD.

Note



The 16bit-versions neither change the registry nor any INI-files of your WINDOWS-system. The 32-bit versions create the HKEY_CURRENT_USER\Software\ReinhardtGmbH\Wetter\... key in the registry which is only created when running and is not deleted when the software is uninstalled.

After the software has been installed you connect the 7-pole plug to the POWER connector of the MWS 5MV / MWS8. At the MWS 5MV you need to remove the lower 3 elements of the radiation shield by loosen the upper 3 pagoda screws to perform.

See also the mounting hints on the weather CD!

3.1 Starting the Software

Start the software by double-clicking the program icon

After every start, the software checks the clock of MWS 5MV / MWS8 and compares it to your computer clock. If it differs more than set in the file WEATHER32STATION.INI the software sets the MWS 5MV / MWS8 clock automatically. Needless to say, the clock of the connected PC must give the correct time, as MWS 5MV / MWS8 is set to the PC-clock.

If your MWS 5MV / MWS8 holds a GPS-receiver, it provides the correct time for MWS 5MV / MWS8.

NOTE



In this case the weather station's clock CAN'T be set by the software! With the GPS receiver you start the software with the parameter -GPS (See software manual) for otherways there may be problems showing and storing data due to wrong time synchronisation!

Data recording to hard disk is started in the selected time interval (5 minutes by default). The software should run for at least one memory interval so that at least one data file is stored on the hard disk. This is important for reading out the datalogger later. (If there is no data file on the hard disk, the datalogger cannot be read out as the software does not find a start date.)

NOTE



MWS 5MV / MWS8 only starts recording data to its datalogger after the time has been set. This guarantees that the datalogger holds only data with the correct time. On the other hand this also means that after a power failure data are only written on the datalogger after the clock has been reset! If you need unbroken data, you should use your MWS 5MV with a UPS (Uninterruptable Power Supply) or the optional GPS-receiver which automatically provides MWS 5MV / MWS8 with the correct time.

If the software is not started, there might be a faulty data file on the hard disk or not enough free memory. This causes an abort.

The manual for the latest software you'll find [here](#).

3 Technical details

The standard datalogger of MWS 5MV / MWS8 can store data of more than 20 days, with data compression up to more than 30 days. These specifications refer to a memory interval of 5 minutes and the sensors set by default. Smaller memory intervals and more sensors reduce the period of time which is covered with the datalogger, larger intervals and less sensors extend it.

3.1 In case of power failure

The datalogger of MWS 5MV / MWS8 is kept up in case of power failure (EEPROMS), but no new data are stored.

In case of power failure, the clock of MWS 5MV / MWS8 does not run on and must be reset after power returns. This can be established automatically by an optional GPS-receiver (i.e. Garmin GPS-35) or manually by restarting the software.

After power has returned, data are only stored in the datalogger after the clock was reset.

Missing data are indicated by measure values of -99999 in the datafile. The software then recognizes in the values of -99999 that data are missing and creates a gap in the graphical displays.

You may also set MWS 5MV / MWS8 in such a way that it writes into the datalogger in the set memory interval as soon as operating voltage is applied. Then the datalogger contains data with the wrong time and cannot be read out by the delivered software. You will need your own application then !

3.2 Maintenance

Because of its elaborated sensors, MWS 5MV / MWS8 needs no maintenance.

Our warranty ends if there is any intervention into hardware or software from your side.

MWS 5MV / MWS8-weather station has been developed for stationary use under normal climatic conditions (temperate zone). Use under extreme conditions such as e.g. on board of a ship, mobile use on a measuring vehicle etc. has not been tested. It is therefore not recommended to set up the weather station where it is exposed to salt or salt water (e.g. right at the coast etc.).

It can be used on a measuring car under certain conditions although the measured values of the wind sensors cannot be reproduced.

3.3 The sensors

3.3.1 The Temperature Sensor

Temperature measurement is based on a precision PT100. The resulting measured value is linearised by the software. By standard, the temperature sensor is mounted on the lower side of the weather station. A white laquered pagoda protects against radiation and prevents a buildup of heat. Range: from -40 °C to + 60 °C, measuring accuracy ± 0.3 °C, (display also possible in Kelvin or °Fahrenheit)

CAUTION: Compared to temperature measurements in big shielded cabins the measured values can be higher when the sun is shining. If the temperature measurements must correlate with the measurements in big shielded cabins you should measure temperature in the shadow or measure with an additional temperature sensor placed in the shadow or in a big shielded cabin!

3.3.2 The Humidity Sensor

is a fast responding capacitive sensor (monolithic) which is based on a dielectric with variable humidity (capacitance). In proportion to humidity the electronics create a signal with changing frequency which is evaluated by the microprocessor. The sensor is also mounted on the lower side of the weather station. A Gore-Tex cover protects it from pollution or destruction by dust or insects. The humidity sensor can be used in a temperature range between -40 °C to + 60 °C. It is linearized to an accuracy of 2 %.

Range: from 10 to 100 %, measuring accuracy ± 2 %, display also as dewpoint measurement in °C or °F

NOTE



This sensor is very responsive to static charge and air pollution (dust, aggressive gases, but also salt). Please note that under unfavourable conditions (i.e. microbic stress caused by moulds, bacteria) this sensor ages faster than under normal conditions.

3.3.3 The Pressure Sensor

is a monolithic, laser-trimmed sensor for absolute pressure which is linearized to 5 hPa for the whole temperature range, i.e., the barometer is temperature compensated. Another temperature linearisation reduces the deviation to less than 2 hPa over the whole temperature range. The measuring signal is elaborated by an instrumental amplifier. The sensor can be used in the temperature range of -40 °C to + 60 °C.

Measuring range: from 600 hPa to 1100 hPa with ± 0.8 hPa accuracy; display can be reduced to 0 m above sea level (input of the local altitude in [m], display also in mm mercury column or Inch mercury column).

This sensor can be used at altitudes from 50m below zero up to altitudes of 3000m. Other altitudes are possible on request.

This sensor can be transported by air cargo!

3.3.4 The Wind Speed Sensor

is made up of an anemometer with magnetic scanning. Wind speed is measured without touch using a Hall-sensor. A peak detector finds every wind peak and hands them on the measuring software. An average value is determined within the respective memory intervals.

Range: in km/h from 0 to 150 km/h with ± 2 km/h measuring accuracy, (display also in m/s, miles/h, Knot or Beaufort), starting speed < 0.5 m/s.

As we have a very comfortable, 3-fold way of measuring wind speed with current wind speed (WG), average wind speed (WD) and wind peaks (WS), you can conform your wind measurement to your very needs.

Please note that dependent on the current winds, the 3 different methods of measuring wind speed can result in very differing graphs: When measuring WG, only a current value is written in the selected measuring interval, when measuring WD and WS, there is continuous evaluation and the whole measuring period is monitored.

3.3.5 The Wind Direction Sensor

There is a weather vane with a precision magnetical encoder and a rotation angle of 360° for measuring wind direction. Wind direction is given in $^\circ$, with 90° being East, 180° being South, 270° being West and 0° being North.

Range: in 360° , measuring accuracy 5° , starting speed, < 0.6 m/s, hysteresis $< 8^\circ$.

Please note, that in North direction (changing from 360° to 0°) wrong values may occur! This is caused by switching from maximum to minimum value of winddirection. To get highly accurate winddirection measurement, you should use the sensor with the identifier WV (main winddirection). This sensor is averaged over a storage interval so that these rare faulty values don't lead to wrong measurement.

Output is performed as WR (current winddirection) and WV (main wind direction within a storage interval). The value WR always has got a value between 0 and 359.9° . WV only has got values between 0 and 359.9° if $WG > 0$. If $WG = 0$, WV has got a value of -99997, which means, that no valid value for the main winddirection is available. This is clear for when windspeed = 0 no main winddirection can be calculated.

3.3.6 Rain / Precipitation Sensor (Option)

A self-emptying bucket is tilted by the collected rain. All the water that has been collected on the normed area of 200 cm^2 is led through a funnel to the bucket. The bucket tilts whenever a certain quantity of water has been collected. The tilting creates pulses which are counted. Out of the pulses, the software calculates the rain that has fallen per m^2 . The current intensity of rain is also found and displayed.

Range: from 0 to 5000 ltr/m^2 ,

Measuring accuracy $\pm 0.2 \text{ ltr/m}^2$

3.3.7 Light Intensity Sensor (Lux-Sensor) (Option)

measures light intensity in Lux. Measuring range is from $370\text{nm}..680\text{nm}$.

Range: from 0 to 150000 lx

Measuring accuracy $\pm 6\%$

3.3.8 Ultraviolet-radiationsensor (UV-Sensor) (Option)

measures ultraviolet radiation in a wide spectrum in mW/m^2 . The spectral range is $210\text{nm}..380\text{nm}$.

Range: 0 to 15000 mW/m^2

Measuring accuracy: $\pm 10\%$

3.3.9 Additional Sensor

Any kind of sensors can be integrated as additional sensors. The information signal must be applied as voltage in the range between 0 V and + 4.095 V or it has to be adapted to MWS 5MV / MWS8 by a special amplifier. Negative or higher voltages are blocked, but out of security reasons, should be avoided in any case!

The sensor signals are linearised by software.

We deliver an additional temperature sensor for measuring soil or water temperature.

Additional sensors can be voltage supplied by the weather station as long as their current consumption is below 25 mA.

NOTE

If current consumption exceeds this value, we cannot grant that MWS 5M weather station works properly !!!

If they need higher currents, the sensors must have an external power supply and its ground has to be connected to the MWS 5MV / MWS8-ground (Pin 1 of the 7-pole connector socket). You can call for adjustment instructions of the additional inputs at any time.

3.3.10 Connecting an Additional Sensor

Additional sensors are connected to MWS 5M at the 8-pole socket.

The socket is allocated as follows:

- Pin1 : GND
- Pin2 : Input for precipitation sensor (TTL-pulse)
- Pin3 : Input for external solar sensor (analog 0..4.095V)
- Pin4 : Input for external lightning sensor (TTL-Pulse)
- Pin5 : Input for analog additional sensor 1 (0..4.095V)
- Pin6 : Input for analog additional sensor 2 (0..4.095V)
- Pin7 : Input for analog additional sensor 3 (0..4.095V)
- Pin8 : Output operating voltage (9..20VDC) maximum 25mA

3.4 Sensor Accuracy

| | |
|---------------------|--|
| Temperature: | ± 0.3 °C |
| Humidity: | ± 2.0 % (at 10°C..35°C) |
| Pressure: | ± 0.8 hPa (at 0°C..50°C), ±2 hPa below 0°C |
| Rain/precipitation: | ± 0.2 mm |
| Wind direction: | ± 5° (at -10°C..50°C), hysteresis < 8° |
| Start speed: | < 0.5m/s (at -10°C..50°C) |
| Wind speed: | ± 2 km/h (at -10°C..50°C) |
| Start speed: | < 0.6 m/s (at -10°C..50°C) |
| Global radiation: | +/- 40W (at 10°C..40°C) |
| UV-radiation: | +/- 10% |
| Light intensity: | +/- 6% |
| Additional sensor: | ± 1 % of final value (at 0°C..50°C) |

3.4.1 Measuring Ranges

| | |
|----------------------|---|
| Temperature: | from -40 ° to + 60 °, resolution 0.1 ° |
| Relative humidity: | from 0 to 100 % resolution 0.1 % |
| Dewpoint: | from -40 ° to + 60 °, resolution 0.1 ° |
| Barometric pressure: | from 950 hPa to 1050 hPa in 0.1 hPa resolution |
| Absolute pressure: | from 600 hPa to 1100hPa in 0.1 hPa resolution |
| Precipitation: | from 0 to 5000 mm with 0.1mm resolution |
| Wind direction: | 0 to 360 °, resolution 0.1 ° |
| Wind speed: | in km/h from 0 to 150 km/h with 0.1 km/h resolution |
| Global radiation: | from 0 to 1300 W/m ² (Spectral range 0.3..2.8µm) |
| Light intensity: | from 0 to 150000 Lux (Spectral range 370..680nm) |
| UV-radiation: | from 0 to 15000 mW/m ² (Spectral range 210..380nm) |
| Additional inputs: | 0- 4.095 V |

Supply 4-28 V, 100 mA at 18 VDC, standard equipment

Dimensions

Size: Outer diameter 90 mm, height 240 mm (MWS 5MV)
Weight: app. 1.05 kg (MWS 5MV)

Size: Outer diameter 130 mm, height 283 mm (MWS 8)
Weight: app. 2.0 kg (MWS 8)

Weight: app. 800 g (10m ready made cable with PSU)

The housing must be mounted centrally on a 1" pipe (until May 2010 with 1"thread).
Standard cabling is 10 m - longer cabling on request.

3.5 Adjustment of Additional Sensors

You will find the adjustment value pairs of your weather station in the MWS5_M.XXX, with XXX a three-digit number.

Additional sensor 1 has got identification ZA, additional sensor 2 has got identification ZB and additional sensor 3 has got identification ZC. The pairs of values of ZA start with !L5, those of ZB with !L7 and those of ZC with !L9.

By default, we have adjusted the additional inputs in mV.

Now you connect the additional sensor to the 8-pole socket or to the collector.

Start a terminal program (e.g. Windows-terminal) and configure as follows: 9600 Baud, 8bit, no parity, 1 Stopbit.

Under Windows-Terminal "Settings" - "Terminal-Settings" you turn on CR->CR/LF when transmitting (This creates a #10 by pressing the Enter-key).

You now change into the adjustment mode of the weather station. All sensors will be output with your frequency.

Here you can find out which voltage is created by your additional sensor at a respective analog value. Expose a temperature sensor to 0°C aus, wait until the sensor has adapted to this temperature and then you see the respective voltage of the sensor. You proceed with e.g. 30°C etc.

Note these pairs of values and replace the respective lines in the adjustment file. It is most important that the first pair of values (e.g. !L5,1,F...) must contain the lowest voltage and the last pair of values must contain the highest voltage.

At least 3 pairs of values must be determined per sensor (e.g. !L5,1F,... to L5,3,W..).

All pairs of values which are not needed must contain voltage 65535!!

After you have determined the necessary adjustment values and entered them in the adjustment file, you can transmit the changed file to MWS 5M as follows:

Start program MWS5MCFG and then enter the name of your adjustment file. The new adjustment files are transmitted now.

This does only work at COM1 or COM2!

Do not in any case change the pairs of values of the other sensors as this would lead to wrong measurements of your weather station.

You will find the necessary parameters for controlling the weather station via Terminal-Program in the technical appendix under Control Parameters.

3.6 Power Supply

9-20 VDC (board versions older than V2.63), 18VDC PSU is standard equipment. Board-versions from 2.63 and newer have got an internal swichting regulator which allows power supplies from 4V..28VDC at about 100mA at 18VDC. (Available since March 2010). When connecting any additional sensors, please note, that the supply voltage for the additional sensors is lead via a reverse polarity protection diode from the weather station's PSU.

Caution: Some additional sensors (LUX-sensor, Rain detector;..) need at least 9 VDC for proper operation!

Please note, that the fan is designed to run with power supplies from 9..28VDC. Lower voltages are possible with special fan regulators, but current consumption then will increase.

3.6.1 Power consumption

Typical power consumption of MWS 5MV / MWS8 at different voltages:

| | | |
|------------------|-----------|--------------------------|
| Current at 8VDC | : 193mA, | power consumption: 1.54W |
| Current at 10VDC | : 148mA, | power consumption: 1.48W |
| Current at 12VDC | : 123mA, | power consumption: 1.48W |
| Current at 18VDC | : 88.8mA, | power consumption: 1.60W |
| Current at 24VDC | : 82.5mA, | power consumption: 1.98W |
| Current at 28VDC | : 80.0mA, | power consumption: 2.24W |

3.7 Data Format

The data format of the transmitted data looks like this:

Example of a datastring :

15:24:32, 15.09.03, TE22.09, DR952.25, WR78.91, FE35.58, WG0.00, WS4.11, WD494.29, WC22.09, WV80.79,

Every 2 seconds, MWS 5M transmits a data record which starts with time and date. Separated by comma, the single measured values with sensor identification come in the following order: Temperature (TE), barometer (DR), wind direction (WR), prevailing wind direction (WV), humidity (FE), wind speed (WG), wind peak (WS), average wind (WD), windchill (WC).

The datastring ends with <CR><LF>, since firmware 2.16 each datastring which is written in the internal logger includes an additional ASCII #31 in front of <CR><LF> for data-synchronisation with the software.

By default, the data are transmitted with 9600BAUD, 8bit, no parity and a stopbit. (For evaluation with your own software, you can set several output modi - see appendix)

On harddisk, a data file is created every month with a format which is similar to that of the transmitted data. The data files receive the extension .MWS

Example : The file of June 2010 is named 06_10.MWS when using 16-bit versions of the software and 06_2010.MWS with 32-bit software.

In case of missing data (cause by power fail, etc.) the software writes data with measuring values of -99999 to ensure integrity of the time axis. The software construes these values (-99999 and -99997) as missing data and creates measurement gaps in the graphical displays.

Please note: The 32-bit software-versions are able to read the data of the 16-bit software-version but not vice versa!

3.8 System requirements

3.8.1 System requirements (16bit versions)

The MWS 5MV / MWS8-software needs a computer with at least SX-386 Processor 4MB RAM (2MB of which must be free (XMS)).

You need a free COM-Port (COM1 or COM2, with Windows-versions COM3 or COM4 as well).

If you use COM3 or COM4, please note that it is only possible to switch interrupts for COM3 and COM4 with special interface boards! If you do not have such a board, there will be problems if you use devices at the same time on COM2 and COM4 or COM1 and COM3, because the interfaces use the same interrupts by default.

COM3 and COM4 are only available with the WINDOWS-version!

We recommend a mouse (MS-compatible)..

If you use a computer without serial port a RS232 to USB converter, TCP/IP Converter or WLAN modules are available to connect your weather station.

3.8.2 System requirements (32bit-Versions)

At least a computer mit Pentium1 / 200 processor and 32MB RAM.

Runs with WIN98 SE, WIN ME, WIN 2k, WIN XP, Vista and WINDOWS 7.

3.8.3 System Requirements for DOS-Versions

- MS-DOS Vers. 4.0 and later
- HIMEM.SYS Driver in CONFIG.SYS
- FILES = 30 Entry in CONFIG.SYS (at least 30)
- if possible, no EMM386.EXE; if absolutely necessary with extension call RAM (DEVICE = EMM386.EXE RAM in CONFIG.SYS)
 - Minimum 1.6MB free XMS-memory

3.8.3.1 SMARTDRIVE

If you have installed SMARTDRIVE, you must limit its memory demand by changing the respective line in AUTOEXEC.BAT:

```
C:\DOS\SMARTDRV.EXE /X... change into  
C:\DOS\SMARTDRV.EXE 1500 /X...
```

Limitation to 1500kB is recommended with 4MB main memory; if there are 8MB and more, a limitation to 4 MB will be sufficient.

If the memory for SMARTDRV is not limited MWS 5-software may abort under certain circumstances with the error message RAM full and the computer may crash.

Using the F1-key or the "?" in the menu bar, you can call the Online-Help at any time.

4 Connections and Pin assignments

4.1 Cables

4.1.1 Data Cable - Allocation of the Connection Cable for MWS 5M / MWS8

| | |
|--|----------------------------|
| 7 pole connector (MWS 5MV / MWS8-connection) | 9-pole interface connector |
| Pin 1 (GND) ←————→ | Pin 5 (GND) |
| Pin 2 (GND - used for MWS 9-5) | |
| Pin 3 (RXD-MWS 5M) ←————→ | Pin 3 (TXD-PC) |
| Pin 4 (TXD-MWS 5M) ←————→ | Pin 2 (RXD-PC) |
| Pin 5 (VCC 18VDC) | |
| Pin 6 (R- with RS422 /485) | |
| Pin 7 (T- with RS422 /485) | |

Connect Pin 4 and 6
Connect Pin 7 and 8

The data cable can be lengthened to up to 50 m. under optimum conditions and with suited cable (not in industrial environment!!)

In case you lengthen the data cable, please take care that the connections in the connector at the computer must be wired.

(Connect Pin 4 to Pin6 and Pin7 to Pin8).

4.1.1.1 Connection Diagram Standard data cable

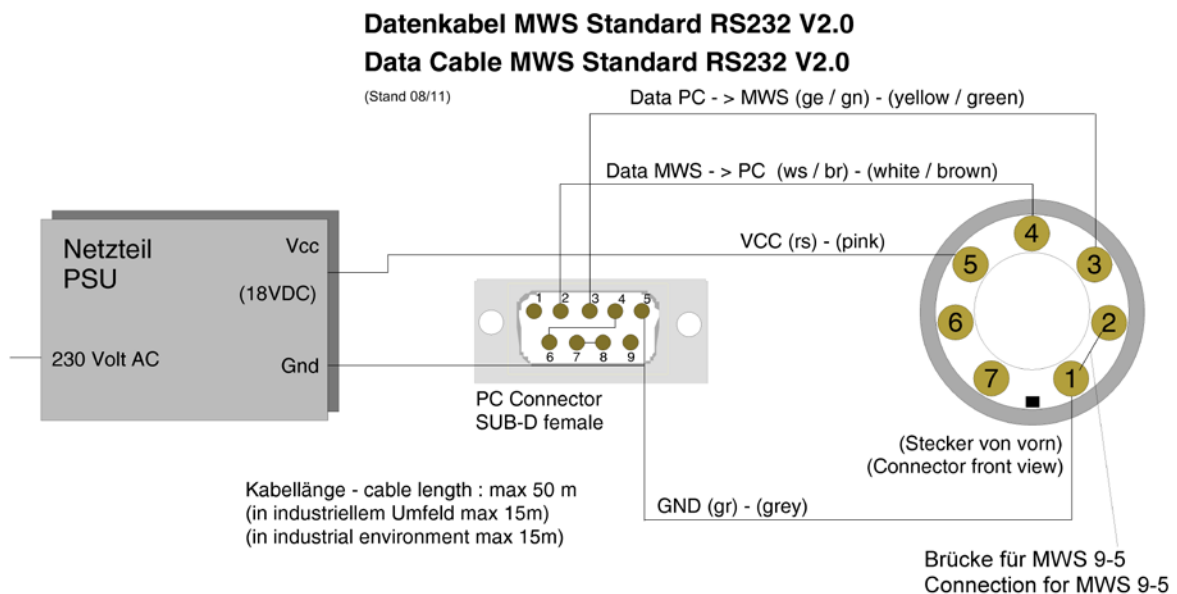

Caution: If you want to use the station for data recording without connected computer, you should disable the COM-port and then connect pin 2 (RXD) and pin3 (TXD) of the 9-pole plug. You may build a connector with these 2 pins shorted and plug it onto the 9-pole female of your RS232 data cable. Don't let the RS-232 female unconnected, for disturbances on the cable may lead to malfunction of the weatherstation then! To connect a PC again, remove the shorting plug, connect the standard cable to the PC and enable the COM-port again.

4.1.2 Allocation of the Connection Cable for MWS 5M Heating

5 pole connector
(MWS 5MV-Heating and GPS-connection)

| | | |
|-------|---------------|----------------------|
| Pin 1 | free | |
| Pin 2 | (GND Heating) | ←————→ GND-PSU 18VDC |
| Pin 3 | (VCC Heating) | ←————→ VCC-PSU 18VDC |
| Pin 4 | free | |
| Pin 5 | free | |

4.1.2.1 Connection Diagram Cable for heating device

MWS Anschlusskabel für Heizung - Connectioncable for Heatingdevice

(alle Ansichten auf die Lötseite - all views onto solder side)

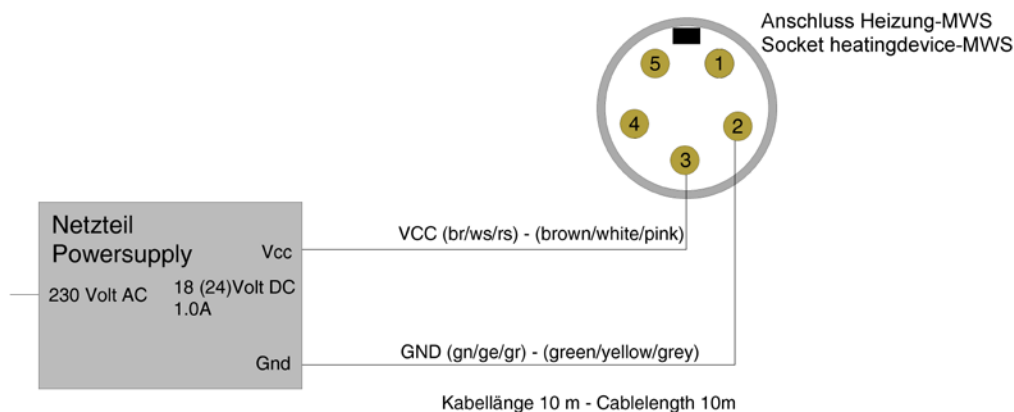

4.1.3 Allocation of the Connection Cable for GPS-Receiver (Garmin GPS16-HVS) :

5 pole connector
(MWS 5MV-Heating and GPS-connection)

| | | | |
|-------|---------------------|--------|----------------------|
| Pin 1 | (GND GPS) | ←————→ | Garmin GPS16-HVS GND |
| Pin 2 | free | | |
| Pin 3 | free | | |
| Pin 4 | (Signal GPS) | ←————→ | Garmin GPS16-HVS Out |
| Pin 5 | (VCC GPS-10..24VDC) | ←————→ | Garmin GPS16-HVS VCC |

NOTE

The cable for the heating is 10 m long and can neither be lengthened nor shortened.
A GPS-receiver is connected to an MWS 5M with heating via the combined socket for GPS and heating with 2 separate cables and a special adaptor.

Manual MWS 5MV und MWS8

4.1.4 Allocation of the Connection Cable for Heating and GPS-Receiver (Garmin GPS16-HVS):

5 pole connector
(MWS 5MV-Heating and GPS-connection)

| | | |
|---------------------------|---------|----------------------|
| Pin 2 (GND Heating) | ←—————→ | GND-PSU 18VDC |
| Pin 3 (VCC Heating) | ←—————→ | VCC-PSU 18VDC |
| ----- | | |
| Pin 1 (GND GPS) | ←—————→ | Garmin GPS16-HVS GND |
| Pin 4 (Signal GPS) | ←—————→ | Garmin GPS16-HVS Out |
| Pin 5 (VCC GPS-10..24VDC) | ←—————→ | Garmin GPS16-HVS VCC |

NOTE

The cable for the heating is 10 m long and can neither be lengthened nor shortened.
A GPS-receiver is connected to an MWS 5M with heating via the combined socket for GPS and heating with 2 separate cables and a special adaptor.

4.1.5 Allocation of the Connection Cable for Sensors with RS422-port

7 pole connector
(MWS 5M-power supply and data-connection)

| | | | |
|--------------------------------|---------|----------------|----------------|
| Pin 1 (GND) | ←—————→ | PSU-GND (grey) | - old: (green) |
| Pin 2 (GND - used for MWS 9-5) | | | |
| Pin 3 (R+ of MWS 5M) | ←—————→ | wire (yellow) | |
| Pin 4 (T+ of MWS 5M) | ←—————→ | wire (white) | |
| Pin 5 (VCC 18VDC) | ←—————→ | PSU-VCC (pink) | - old: (brown) |
| Pin 6 (R- of MWS 5M) | ←—————→ | wire (green) | - old: (pink) |
| Pin 7 (T- of MWS 5M) | ←—————→ | wire (brown) | - old: (grey) |

MWS Datenkabel RS422 - MWS Datacable RS422

(Stand 08/11)

(alle Ansichten auf die Lötseite - all views onto solder side)

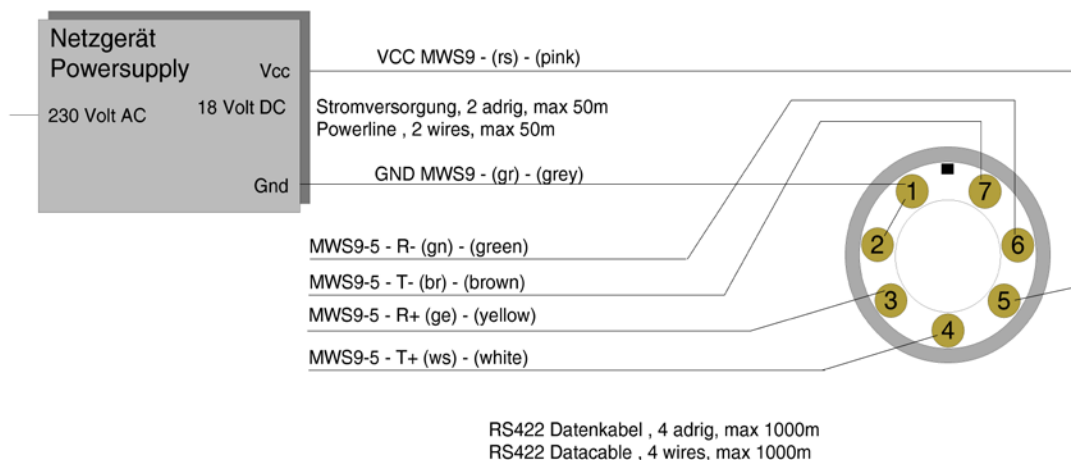

4.2 Pin assignments

4.2.1 Allocation of the MWS 5MV / MWS8-Connection Sockets

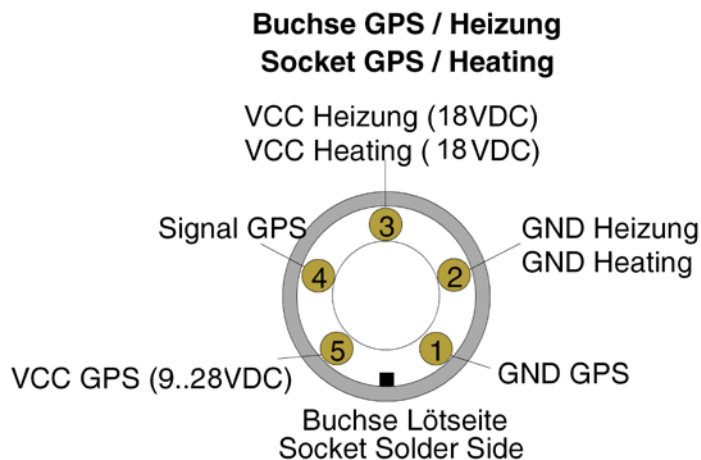
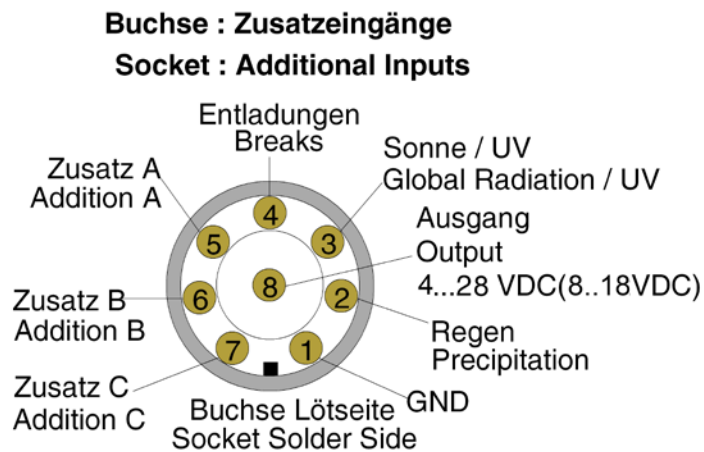
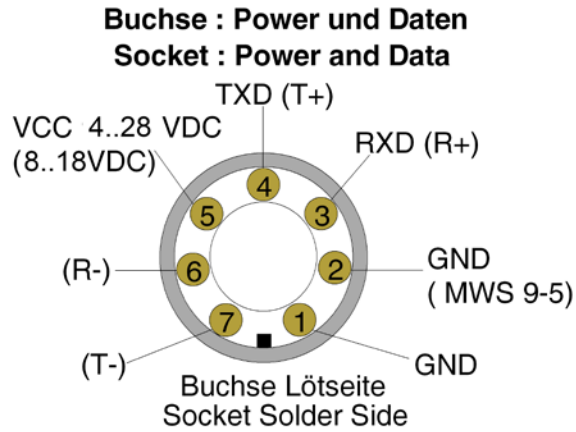

5 Excerpts from the Directions of DWD for Automatic Weather Stations

2.2 Regulations for Installation

2.2.1 Demands on Location

When you choose a place for the weather station, there must be no impediments, its horizon must be free. Soil and plants must be representative for its surroundings.

For measuring wind it is compulsory that there are no obstacles. Measuring the duration of sunshine especially is based on a free horizon.

When transmitting stations such as directional radio or installations for air traffic control are near, there must be additional shielding.

...

All preventive measures will prove useless if radio medium frequency transmitters are around.

2.2.2 Measuring field

The measuring field ought to be 10 x 10m, but at least 6 x 6m...

3. Sensors

3.1 Measuring air temperature 200cm

By standard, air temperature is measured 2m above ground...

In order to keep radiation errors as low as possible, air temperature ought to be measured in a weather hut...

3.4 Measuring relative air humidity 200cm

By standard, relative air humidity is measured 2m above ground...

3.5 Measuring precipitation 100cm

...

The collecting area is 200cm². The Hornersche Wippe (see-saw) tilts when it is filled with 2cm², i.e. 0.1 mm precipitation.

3.7 Measuring windspeed

A cup anemometer is used for measuring wind speed. Its rotational speed is proportional to the horizontal wind speed.

3.8 Measuring wind direction

A wind vane with a perpendicular rotary shaft is used for measuring wind direction. Its orientation in the wind results from the pressure difference on both sides of the vane.

By standard wind direction and wind speed is measured 10m above ground

6 Trouble Shooting

If the weather station is placed and mounted as described, there should be no problems in recording data.

When having problems with data transmission, you may decrease the Baud-rate or shorten the cable. You should use low capacitive cable when using cable length over 15m (RS232).

Using the weatherstation in industrial environment can cause big problems in data transmission or even storing in the logger, when disturbance scatters into the cable. In this case you should use shielded cable or use RS422 Interface.

If the sensor has got any kind of malfunction (i.e. no windvalues, no rain measurement,...), you've got the possibility to reset the Sensor without plugging off the cable. The command for resetting the Sensor is !*. The Sensor then stops triggering the watchdog and a complete reset is performed after 1.6 seconds. The Sensor now will startup in the same way like the cable is plugged in the first time. For this the clock needs to be set again!

(Further hints on the weather CD under FAQs.)

6.1 Fault Protocol File (16 bit versions)

Important in case of fault

Whenever you restart the software, all versions of the weather software later than V1.06 create a protocol file of the data transmissions between PC and weather station. With DOS-versions this file is called DIAGNOSE.LOG, with WINDOWS-versions DIAG_WS.LOG.

This file can help you, so do save it **in any case**, as it is overwritten whenever you restart the software.

Please see the files .DOC or .DOK too. You will find important new information on the MWS 9-5-software which is not yet in this manual.

6.2 Protocol-files (32 bit versions)

6.2.1 Log-file in case of error (ErrLog.txt)

Softwareversions for sensors without logger same or newer than V2.26 write a log-file (**ErrLog.txt**) in case of errors (dataerrors or transmission problems), in which the timepoint and kind of the error is stored. Older versions displayed an error-message like **!p** or **data error**, which was displayed permanently until the user clicked it away. This caused the problem that no further data were written for the time the message was visible although the error did not exist any longer.

In version same or newer V2.26 also an error message appears, but this message is deleted automatically when the error is removed. In this case an entry is written into the log-file.

6.2.2 Logfile when starting up (log.dat)

When the software for weatherstations and sensors with logger is started, the communications between the computer and the weatherstation is stored in a log-file (**log.dat**). With this file you may get important hints in case of problems.

Caution! This log-file is overwritten each time, when the software is restarted. To keep this file, store it in another place or rename it.
software.

6.3 RS422/RS485 port

Using RS422/RS485 needs special treatment (only old versions):

After applying power to the weather station or after power fail the TX-wire of the weather station is disabled (set to TRI-state) due to safety reasons, this means that the weather station sends NO data.

To enable the weather station, you need to transmit a ? (ASCII 63) to the weather station. Only then the weather station begins to send data.

When using the enclosed REINHARDT software this will be performed automatically!

Otherways you may use the tool ENA422.EXE which allows to send a string to the weather station over the COM-port.

To do this, at first the COM-port settings need to be set with the tool „MWS5MSET.EXE“, for writing the INI-file „WS_CFG.INI“ for the COM-port.

Then you can send the required ? to the weather station with „ENA422 P-?“ .

CAUTION:

Firmware versions from 2.17 or later activate the COM-port immediately!

Thus with RS422 data will be sent without enabling of the COM-port.

With RS485 the port also is active immediately after power is applied, but of course no data will be visible on the data lines for with RS485 data are only sent on request.

Initialisation of the weather station and memory check are performed as well, like with all other COM-port configurations, but you won't see any data on the COM-port for the output is TRI-state!

While initialisation, which will need up to 2 minutes, the weather station will not accept any command!

To send a command to a weather station with RS485, you always must insert the device address of the weather station between the ! or the ? and the command, otherways the weather station won't accept the command! Default address of weatherstations with RS485 is 1.

The command for reading the latest datastring is ?1U (opposite to ?U with all other COM-port configurations)!

7 Options

More additional modules you can find here:

http://www.reinhardt-testsystem.de/english/climate_sensors/additional_modules.php

7.1 Option LCD-Display

The optional LCD-display for MWS Weather Stations and climate sensors displays the weather data and, if you like, also time, date and up to 4 comment lines in an automatic run.

7.1.1 Ways of displaying the data

Display can be in parallel to recording with the PC or even without a PC.

If the display is connected to a PC, you connect the standard-MWS5-cable to the display and connect it to the COM-Port of the PC (connection cable LCD - PC).

NOTE



For use of the LCD-display, you need a power supply with a special wiring (Standard supply with 12VDC voltage applied to pin 1 of the 9-pole interface connector!).

Never connect this cabling with its special wiring to the interface of your PC, as the 12 V at pin 1 of the interface connector might destroy the PC-interface !!!

7.1.2 Changing the Configuration

A terminal program helps to display all sensors, time, date and comment lines on the LCD display. Turn the switch on the rear of the LCD to "SET" in order to set this.

After you have switched the SET-mode, you ought to plug in and out the voltage supply of the display (9-pole connector) for initialising.

Start a terminal program with data of interface and Baud-rate and make your settings (e.g. terminal #2 9600).

When you are in the SET-mode and make your settings, both display and terminal program will send the message "Keine Wetterdaten" about every 5sec, as in the SET-mode the connection to the weather station is interrupted.

When you set the display, please wait for the message "Keine Wetterdaten" after the data are transmitted (#10 - Line feed) before you enter the following parameter; otherwise the display possibly does not react on your new entry.

After you have made all your settings, you turn the switch to "STANDARD" and initialise the display by plugging in and out the voltage supply. It takes about 20sec (max.), until the display receives data from the weather station and displays them.

If a MWS5MV weather station is connected to your display, time and date will be adopted from MWS5MV.

NOTE

While you make your settings in the SET-mode, no data are transmitted from the weather station to PC or display !!

7.1.3 Commands for Controlling the Display

7.1.3.1 Control parameters

| | | |
|---|---|--|
| <i>Fade out sensor</i> (maximum 1 character) | : | !S<SENSORNUMBER>,a #13 |
| <i>Fade in sensor</i> (maximum 1 character) | : | !S<SENSORNUMBER>,e #13 |
| <i>Text in clear for sensor</i> (maximum 10 characters) | : | !T<SENSORNUMBER>,<TEXT> #13 |
| <i>Unit for sensor</i> (maximum 5 characters) | : | !E<SENSORNUMBER>,<UNIT> #13 |
| <i>Output position of a sensor</i> | : | !K<SENSORNUMBER>,<IDENTIFICATION> #13 |
| <i>Input of comment lines</i> (maximum 21 characters) | : | !W<LINENUMBER (0..3)>,<TEXT> #13 |
| <i>Setting speed</i> (factors 0 to 10 are possible; rate of change is calculated as follows: Time = Factor * 2.55 + 4.55 seconds) | : | !D<Factor> #13 |
| <i>Selecting the clock</i> | : | !U<I / E / K> #13 (internal, external, no) |
| <i>Setting Time / Date</i> | : | !U<SSMMSSTTMMJJ> #13 |
| <i>Status query</i> | : | ?S#13 |
| <i>Little help</i> | : | ?H #13 |

Default sensor numbers (maximum 2 characters):

| | | |
|----|---|---------------------|
| 00 | : | Time |
| 01 | : | Date |
| 02 | : | Temperature |
| 03 | : | Windchill |
| 04 | : | Pressure |
| 05 | : | Humidity |
| 06 | : | Solar Energy |
| 07 | : | UV-Radiation |
| 08 | : | Precipitation |
| 09 | : | Wind Speed |
| 10 | : | Wind Peak |
| 11 | : | Average Wind |
| 12 | : | Wind Direction |
| 13 | : | Leaf Moisture |
| 14 | : | Lightning / Breaks |
| 15 | : | Additional Sensor A |
| 16 | : | Additional Sensor B |

NOTE

You create a "#10" (Line feed) by holding down the ALTGR-key and typing 10 (number part of your keyboard) and then leave go the ALTGR-key or by holding down the STRG (CTRL)-key and using the ENTER-key!

External failures (power failure, HF-interference, operating error, ...) can in the worst case reset the microcontroller to its default values. This means that baud rate and display rate may change so that the changed values could give the wrong impression that there is a defect. Baud rate by default is 4800 BAUD and the maximum display interval is about ca 30 sec.

7.2 Other available displays

7.2.1 Meteograph

Precision analog display with high grade stepping motors.
For indoor use only.

7.2.2 DKA1

LED mini display for alternating of up to 9 values. 13 mm digit size.
For indoor use only.

7.2.3 DMG

Big digital meteo display similar to DKA1 bit 57 mm digit size.
For indoor use only.

7.2.4 DMMG

Big digital meteo display for displaying 10 parameters simultaneously with digit size 57 mm.
For indoor use only.

7.2.5 DMMK

Small digital meteo display for displaying 10 parameters simultaneously with digit size 13 mm.
Available for wall mounting or placing on a table.
For indoor use only.

8 Technical Appendix

8.1 Control parameters for calibrating an additional sensor

PLEASE NOTE:

<#13> stands for ASCII-character 13, (Carriage Return).

The command can also be closed with <#13><#10> (<CARRIAGE RETURN> - <LINE FEED>, i.e. <CR><LF>).

Changing from Measured Value output and Adjustment Mode (voltage output):

!' 'W' <#13>

Transmitting the linearisation data:

!' 'L' <SENSORNUMBER> ',' <INDEX : 1..6> ',' 'F'
<VOLTAGE(mV)> <#13>

!' 'L' <SENSORNUMBER> ',' <INDEX : 1..6> ',' 'W'
<ANALOGVALUE> <#13>

E.g.: You measure 3054 V at 24.5 °C for additional sensor A in the 3rd position of your adjustment table, it will look like this :

!L14,3,F3054 <#13>

!L14,3,W24.5 <#13>

8.2 Controlling the Microcontroller

8.2.1 Input parameters of MWS5MV / MWS8 -Microcontroller

Reset (Versions same or newer than 2.28):

!! '*' <#13>

Changing the BAUD-Rate:

!! 'B' <X> <#13> ; 0 < X < 8 :

BAUD-Rate for X = 0 : 300
1 : 600
2 : 1200
3 : 2400
4 : 4800
5 : 9600 (Default)
6 : 19200
7 : 38400
8 : 76800

Continure reading the logger the output after an interruption

!! 'C' <#13>

NOTE:



After voltage is applied, the sensor ALWAYS is set to 9600 BAUD. If the Baud-rate has been changed by mistake, you can set the sensor to its correct baud-rate during the RAM-test (.....) .

Input-flags for control (e.g. immediate store), !Fx, 0 <= x <= 255

Bit 7 - DEBUG_OUTPUT (In reading out RAM, it also edits @ -
Note : Not in Page mode)

Bit 6 - Output of device address (DA) with <CR><LF> in front of every data record

Bit 5 - Resets the lightning-input once every day (Version 2.24 and later)

Bit 4 - Connection of serial Reinhardt-sensors to the GPS-input (Version 2.24 and later)

Bit 3 - ALTERNATIVE SENSORS (Version 2.13 and later)

(outputs alternative sensors (valuePort A and GPS-satellites) instead of the Standard-sensors in position 31 (PW-FAIL WD) and 32 (PW-Fail))

Bit 2 - De-activates internal GPS-determination of local altitude

Bit 1 - Does not take local altitude from the GPS-receiver

Bit 0 - Immediate Store - Stores immediately after plugging in inspite of incorrect time

Example :

!! 'F0' <#13> ; Writes into the datalogger only after the clock is set

!! 'F1' <#13> ; Writes into the datalogger at once (incorrect time)

!! 'F12' <#13> ; Does not take local altitude from the GPS and outputs alternative sensors

Changing from measured value output and adjustment mode (output of frequency):

!! 'W' <#13>

Fading in/out single sensors (All available sensors are listed on a following page.)

!! 'KX,A0' <#13> ; No output of sensor with output-number X

!! 'KX,A1' <#13> ; Output of sensor with output-number X

Sensor attenuation for turn sensor on / off

!! 'KX,M0' <#13> ; Sensor with output-number X is not attenuated

!! 'KX,M1' <#13> ; Sensor with output-number X is attenuated

Transmitting linearisation data:

!' 'L' <SENSORNUMBER> ',' <INDEX : 1..6>','
'F' <VOLTAGE(mV)> <#13>

!' 'L' <SENSORNUMBER> ',' <INDEX : 1..6>','
'W' <ANALOGVALUE> <#13>

Setting the general averaging size

!' 'MX' <#13> ; 1 <= X <= 255 ; X = 0 : averaging off

Setting local altitude for correct display of barometric pressure

!' 'O' <LOCALALTITUDE(m)> <#13>

Resetting windpeak and average wind

(only if storage interval is set to 0 (deactivated))

!' 'P' <#13>

Setting the compression quality

!' 'QX' <#13>; 2 <= X <= 255 ;
X = 0 : highest compression, (1 complete set/ day)
X = 1 : every record is complete (compression off)
X = 2 : every 2nd record is complete
X = 3 : every 3rd record is complete ...

Resetting the rain/precipitation measurement

!' 'R' <X> <#13> X means every hour on the hour for rain reset, if storage interval > 0
'!' 'R' <#13> Resets rain to 0, if storage interval = 0



Turning on / off the interface (Protocol-Select)

NOTE: These settings are very complicated and sensitive.

In case of wrong operation, the sensor can be obstructed irreparably.

!' 'SX' <#13> Suppresses the data output to the interface
X is the decimal value of the following binary list for the various protocols.

Binary list of the protocol-parameter for X.

X (binary) =

xxxxxx00b : RS232 - MWS 9-5 transmits a data record every 2 sec
xxxxxx01b : RS422 - MWS 9-5 transmits a data record every 2 sec
xxxxxx10b : RS485 - MWS 9-5 is addressed and transmits on request
xxxxxx11b : Profibus - MWS 9-5 is addressed and transmits on request
xxxxx1xxb : MWS 9-5 transmits on request only (RS232 + RS422)
xxxx1xxx b : MWS 9-5 transmits when writing on datalogger and on request
xxx0xxxxb : Output in ASCII-format and German date
xxx1xxxxb : Output in ASCII-format and American date
xx1xxxxxb : Output in compressed format

By combination (addition) of single binary values, you can combine the parameters.

Example for MWS9-5 with RS422 transmits on request only :

X for RS422 (binary) = xxxxxx01

X for transmits on request (binary) = xxxxx1xx

adds --> = xxxxx101 --> Decimal = 5 --> !S5<#13>

CAUTION: With RS485 after the ! or ? always the device address must be inserted! Other ways the command won't be accepted! (Standard@ = 1)

Set date and time:

!' 'U' <TIME DATE in format HHMMSSDDMMYY> <#13>

Example: !U092030100501#13 sets the clock to 9 o'clock 20min and 30sec on 10.5.01

If a GSM900-Module is connected with the weather station also the clock of the GSM900-Module will be set with this command!

!' 'u' <ZEIT DATUM im Format HHMMSSDDMMYY> <#13>

If a GSM900-Module is connected with the weather station only the clock of the weather station will be set, the clock of the GSM900-Module will not be changed with this command by using a lower "u"!

Switch fan off:

!' 'X0' <#10>

Since Micro-version 2.39 (July 2006)

Switch fan on (default):

!' 'X1' <#10>

Since Micro-version 2.39 (July 2006)

Set memory interval for the RAM:

!' 'Z' <INTERVAL in 10 Second-Steps> <#13>

oder

!' 'ZD' <INTERVAL in 2 Second Steps> <#13>

Example: !Z1#13 stores a data file every 10 seconds
!Z3#13 stores every 30 seconds
!ZD5#13 every 10 seconds
!ZD1#13 every 2 seconds
!Z12#13 every 2minutes ...etc
(Maximum Z249 = 41 minutes 30 seconds)

Time zone with GPS-reception (deviation from UTC-time):

!' 'ZZ' <full hours> <#13>

8.2.2 Querying the Microprocessor

Call the current data file:

'?' 'U' <#13>

Read out stored data from address 00H and following

'?' 'Y' <#13>

Read out stored data at a certain time:

'?' 'D' <TIME DATE in format HHMMSSDDMMYY> <#13>

Call all the stored data:

'?' 'D' '000000000000' <#13>

Interrupt the data output:

<#13>

Continue the data output after the moment of interrupt:

!' 'C' <#13>

Call linearisation data, sensor configuration and system information:

!' '?' <#13>

Since μ P Version 2.39 the command !? can be combined with a sensor-number, i.e.:

!' '?0' <#13>

Only the info about the main configuration will be sent.

!' '?1' <#13>

Only the info about the configuration of the sensors will be sent.

!' '?2' <#13>

Only the info about the sensor 2 (temperature) will be sent.

...and so on.

8.2.3 Order of the MWS5M / MWS8 Sensors

| <i>Output-Number</i> | <i>Sensornumber</i> | <i>Sensor</i> | <i>default</i> |
|----------------------|---------------------|-----------------------------|----------------|
| 1 | 1 | Time | on |
| 2 | 0 | Date | on |
| 3 | 2 | Temperature | on |
| 4 | 3 | Global radiation | off |
| 5 | 4 | Pressure | on |
| 6 | 5 | Addition1 | off |
| 7 | 7 | Addition2 | off |
| 8 | 9 | Addition3 | off |
| 9 | 6 | Global radiation external | off |
| 10 | 8 | Wind direction | on |
| 11 | 18 | Prevailing wind direction | on |
| 12 | 10 | Humidity | on |
| 13 | 11 | Rain | off |
| 14 | 12 | Average rain | off |
| 15 | 13 | Wind speed | on |
| 16 | 14 | Wind peak | on |
| 17 | 15 | Average wind | on |
| 18 | 16 | Lightning | off |
| 19 | 17 | Windchill | on |
| 20 | 19 | GPS Local altitude | off |
| 21 | 20 | GPS X-coordinate | off |
| 22 | 21 | GPS Y-coordinate | off |
| 23 | 22 | GPS speed | off |
| 24 | 25 | Internal temperature | off |
| 25 | 26 | Internal reference voltage | off |
| 26 | 27 | Operating voltage | off |
| 27 | 28 | Voltage heating control | off |
| 28 | 29 | Leaf moisture | off |
| 29 | 30 | Powerfail Watchdog | off |
| 30 | 31 | Powerfail voltage regulator | off |

9 Instructions for Mounting the MWS5M Weather Station

Anleitung zum Befestigen der Wetterstation

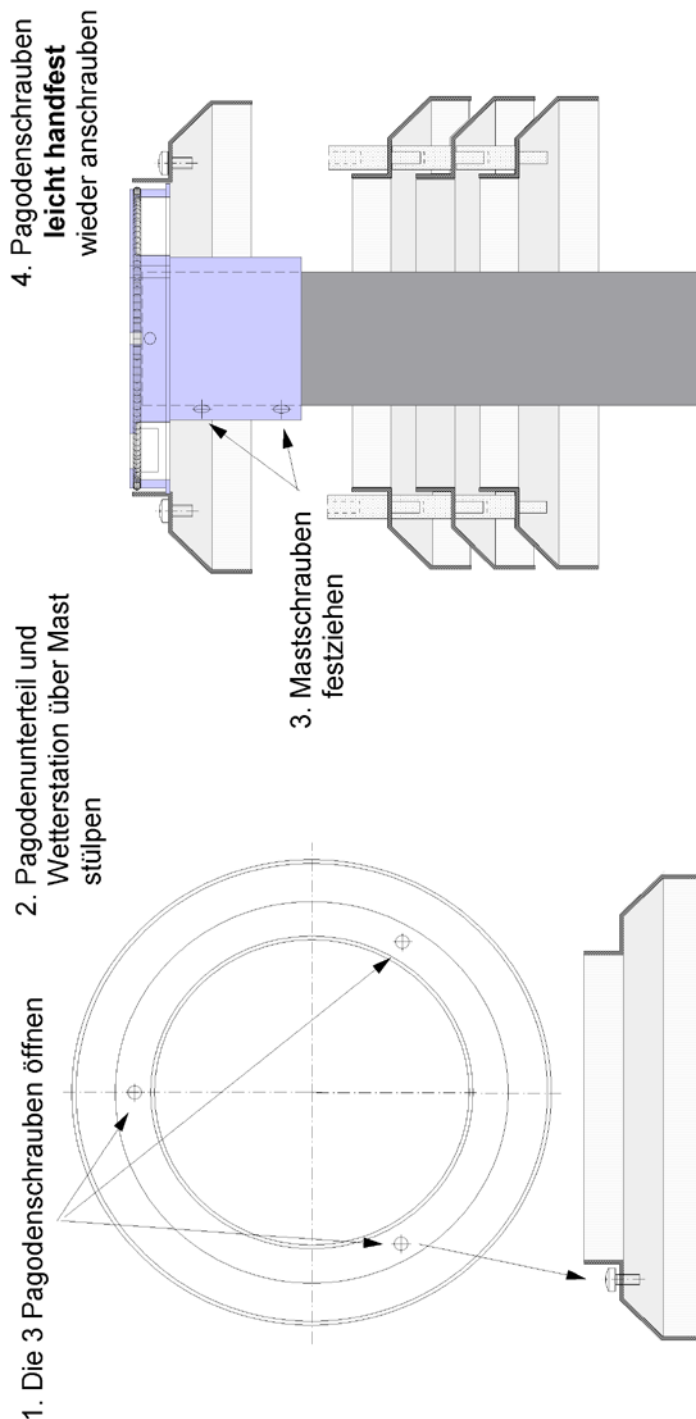

10 Packing MWS 5MV / MWS8 properly

In case you want to ship your MWS 5MV / MWS8, you must use the original packing. This packing was especially designed for MWS 5MV / MWS8. It is the best protection against damage or destruction during transport. In this packing it will not even be damaged if it falls from 1 m height onto a stone floor.



Do not fill the packing with polystyrene flakes. They could damage the wind vanes when the package is closed as there might be high pressure.

11 Exchange Connectors

In case you have to replace connectors, please contact:

Fa. Adam, Tel: ++49 (0)8131 - 2808 51

The connectors belong to Series 711.

Below you will find the order numbers:

5way connector (heating / GPS) : **99-0095-102-05**

7way connector (data and power-supply) : **99-0475-102-07**

8way connector (additional sensors) : **99-0479-102-08**

Of course, you can order the connectors also from REINHARDT.

I&OE / Specifications subject to change without prior notice !
05/12